

ORIGAMI BOAT INSTRUCTIONS

1 FOLD A4 SHEET IN HALF

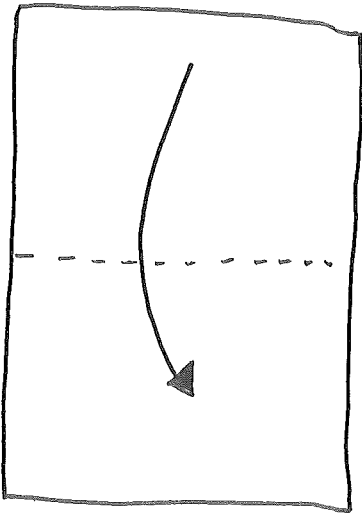

2 TURN 90° AND FOLD IN HALF AGAIN

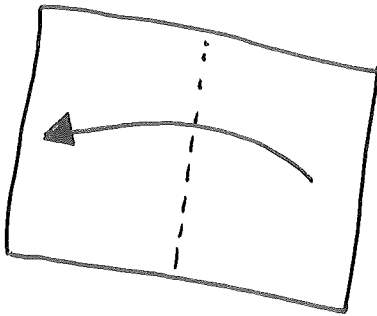

3 FOLD SIDES TO CENTER

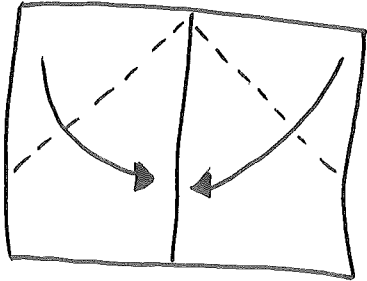

4 FOLD THE OVERLAPPING STRIP UPWARDS

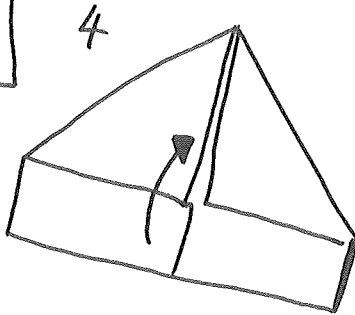

5 FOLD CORNERS BACKWARDS, TURN OVER

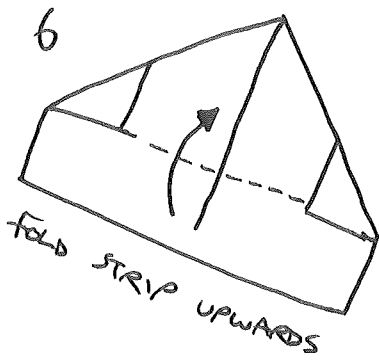
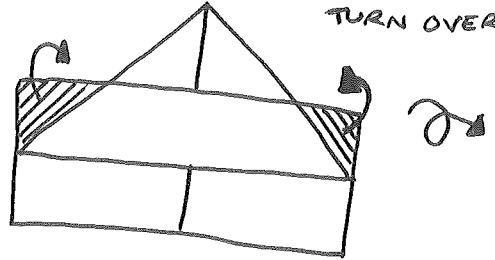

6 FOLD STRIP UPWARDS

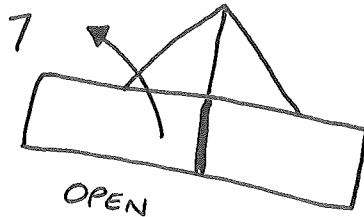

7 OPEN

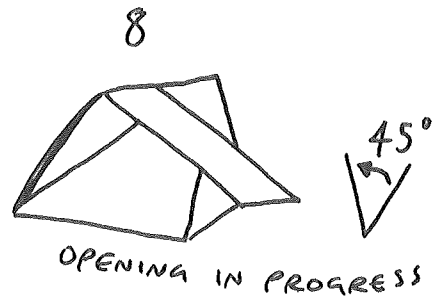

8 OPENING IN PROGRESS

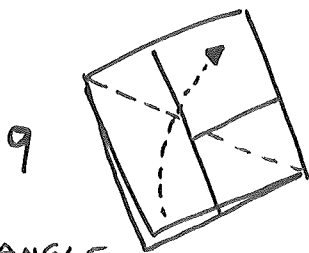

9 FOLD TRIANGLE UPWARDS, REPEAT BEHIND!

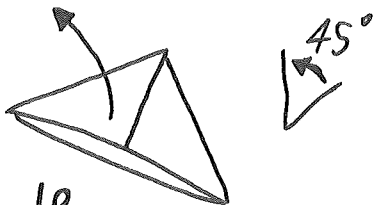

10 OPEN (LIKE STEPS 7 AND 8)

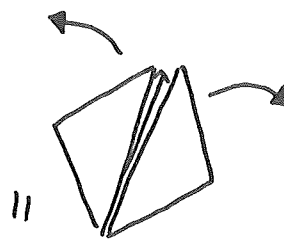

11 TAKE UPPER CORNERS AND PULL OUTWARDS

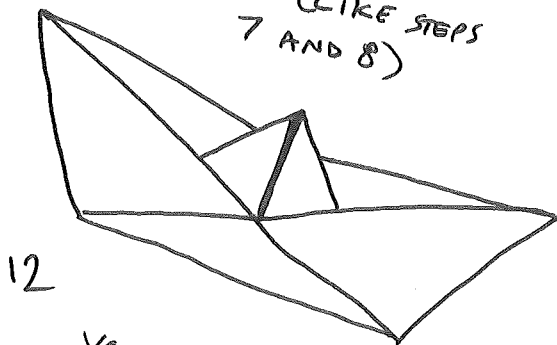

12 VOILA! THE FINISHED BOAT